

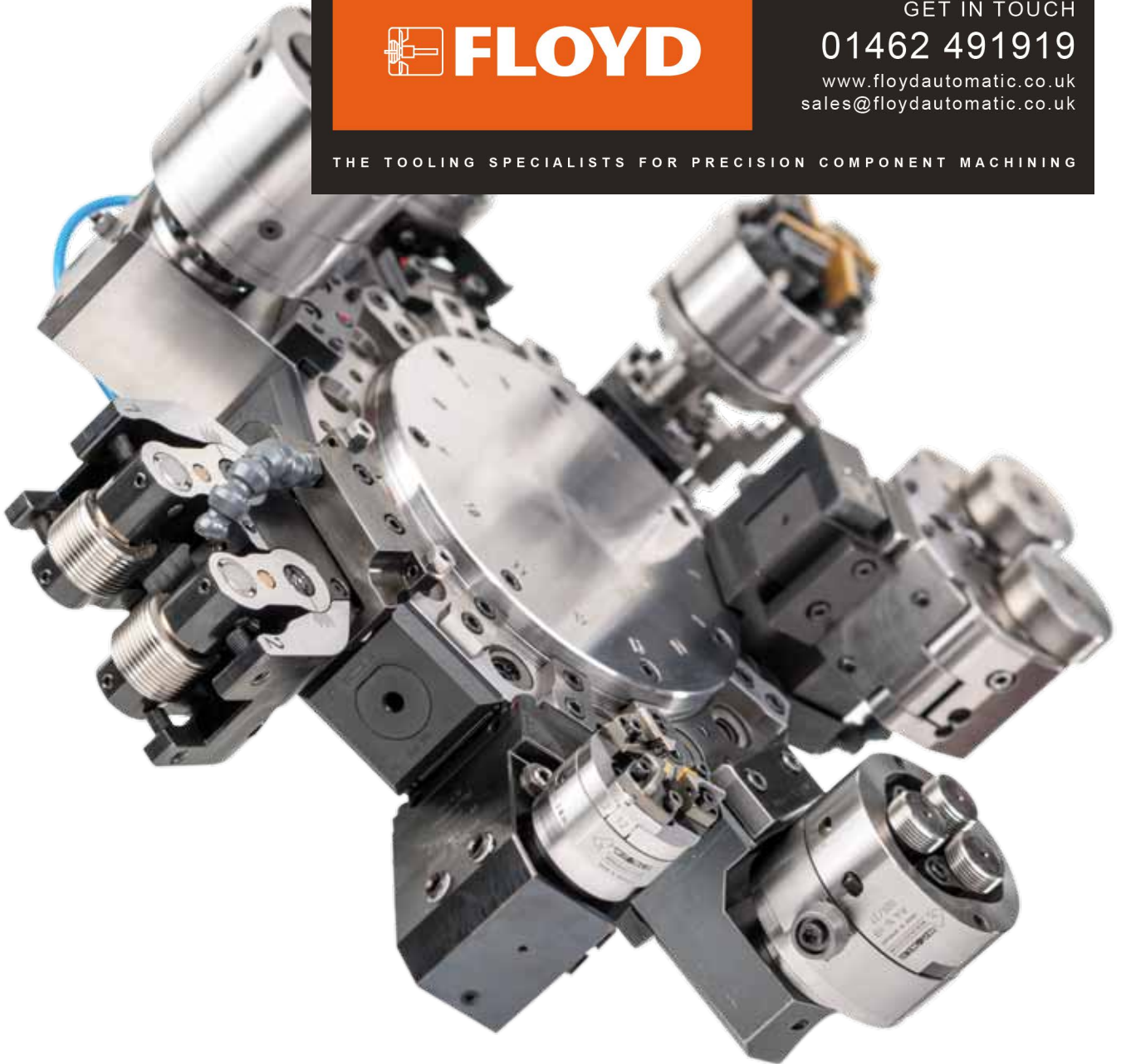

GET IN TOUCH  
01462 491919

[www.floydautomatic.co.uk](http://www.floydautomatic.co.uk)  
[sales@floydautomatic.co.uk](mailto:sales@floydautomatic.co.uk)

THE TOOLING SPECIALISTS FOR PRECISION COMPONENT MACHINING



Expertise covering a wide range of  
cylindrical machining processes

[www.wagner-werkzeug.de](http://www.wagner-werkzeug.de)



# The Company

The change from a traditional company into a company rich in innovations



**WAGNER® Werkzeugsysteme Müller GmbH** specialises in the production of precision tools for use in the efficient production of external threads and special production stages such as beading, crimping, knurling or rolling-in.

The well-proven thread-cutting heads, which stretch back to the long-standing traditions of the Gustav-Wagner-Maschinenfabrik era, have been manufactured in Pliezhausen since 1994. They meet all of the high quality demands placed on them and it was these that brought the fame to the WAGNER® name.

However, it is not just the old, well-proven products that are the best sellers as it is mainly the recently developed rolling heads and the multi-cutter turning heads that are in demand in the market.

The continuous development work undertaken by our engineers ensures that our technology always counts amongst the world leaders. Swabian precision has been used in the development of all of our products in order to meet the growing needs of the market.

We previously introduced a quality management system that complies with DIN ISO, in order to be able to guarantee that we always maintain our high product quality.

A range of products marketed under the "Hofmann" brand name with a worldwide reputation has been included in our portfolio since 2010 and they consist of rotary tables, dividing attachments (both manual and NC-controlled), tailstocks and unwinding stands.

Our extensive experience is combined with fresh creativity, innovative strength and unrivalled expertise when it comes to the measuring and component technology. This makes us a well sought-after partner by renowned manufacturers of machine tools and machining centres for processing metal. An overview of all of our "Hofmann" products is given in a separate brochure and this brochure is available from us.

Small, precise and extremely effective: That describes our Swiss subsidiary company "**Alphatool Werkzeugsysteme AG**", which was founded in Volketswil, close to Zurich, in the Autumn of 1999. The markets in Switzerland, France, Austria, Spain, Italy and Belgium are advised and maintained from there.

You will find a summary of our global sales partners on Page 15.

# Table of Contents

	<p><b>Thread rolling attachments</b>          For threads with a very short run-out, close to a collar, very short threads or threads behind a collar          Threads: Ø 1.6 - 68 mm          Types of threads: For virtually all types of threads          Application areas: For serial parts and large batches</p> <p style="text-align: right;">▶ Page 4</p>
	<p><b>Axial rolling heads</b>          For chip-free production of threads paired with rapidity and economical pricing          Threads: Ø 3 - 70 mm          Types of threads: For virtually all types of threads          Application areas: For serial parts and large batches          Models: Stationary and rotating</p> <p style="text-align: right;">▶ Page 6</p>
	<p><b>Thread cutting heads</b>          For fast, economical and extremely precise production of threads of different shapes, angle, diameters and lengths on numerous materials. Special versions can be supplied for grooving.          Threads: Ø 1.6 - 120 mm or Ø 9 - 175 mm          Types of thread: For virtually all types of threads          Models: Stationary and rotating</p> <p style="text-align: right;">▶ Page 8</p>
	<p><b>Multi-cutter turning heads</b>          For the fast reduction of external diameters. Its 3 or 4 carbide cutters achieve a 3 to 6 times higher feed rate than conventional tools.          Turning range: Ø 2 - 30 mm          Models: Stationary and rotating</p> <p style="text-align: right;">▶ Page 10</p>
	<p><b>Driven tools</b>          Tools for drilling or milling, with or without an internal coolant supply, angle-adjustable tool heads as well as special tool heads.          Versions: Axial or radial, axial offset, shortened or relocated          Tool holders: ER DIN 6499 collet chuck, DIN 6358 milling spindle, DIN 1835 Weldon, thread tap, circular saw blade, Denitool &amp; others</p> <p style="text-align: right;">▶ Page 12</p>

# Thread Rolling Attachments

Tangentially working, chip-free shaping technology



WAGNER® thread rolling attachment rolling threads in front of a collar



Thread rolling behind a collar

The tangentially working **WAGNER® thread rolling attachment** produces threads with a superior surface finish in the shortest machining times possible. The rolled threads are capable of being subjected to great stress thanks to their uninterrupted fibre orientation and they are characterised by their long-life fatigue strength and their resistance to wear and corrosion.

An adapter is used to mount the thread rolling attachment on the tool holder, e.g. turret disc. It moves at a constant rate of advance onto the rotating workpiece. The turning of the thread rolls is offset as they come into contact with the workpiece and it shapes the thread as the tool holder advances. Rapid retraction is initiated as soon as the thread rolls reach the centre of the workpiece and this releases the workpiece.

**High flexibility** is realised by the numerous adapter versions that are available for use with different machines, such as single and multi-spindle lathes as well as other special machines.

**Maximum productivity** can be realised by using precision thread rolls. These can be optimised to match the required pitch, diameter and shape of the rolling thread.

**The best rolling results** in fine-pitch threads are achieved by the use of our tool variant „F“. In case of threads with a very small pitch it is important to keep the axial play of the thread

rolls as low as possible. By means of the patented **WAGNER®** axial play fine adjustment, the axial roll play can be minimised in 0.02 mm steps. The fine adjustment is available optionally for type B14, B16, B19 and can be upgraded by exchanging the gearing arms.

**WAGNER®** thread rolling attachments are available in eight different sizes and they have been designed so that an exceedingly large range of diameters can be machined with each tool.

The preferred areas of application for **WAGNER®** thread rolling attachments are:

- Threads behind a collar
- Threads close up to a collar
- Very short threads
- Threads where the end of the workpiece is not free
- Threads with very short run-outs
- Anywhere where axial machining is not possible due to a lack of space

**Your benefits:**

- Large working area realised through the different adjustment options
- Long working-life thanks to the large rollers and the remarkable rigidity of the tool body
- Extremely low maintenance



WAGNER<sup>®</sup> thread and profile rolls



WAGNER<sup>®</sup> B 16 thread rolling attachment with adapter

**Application areas:**

It can roll cylindrical and conical threads, left and right threads as well as fine-pitch and regular-pitch threads. Profile thread rollers are also available for special applications such as the rolling of lubricating, knurled or smooth grooves.

**Materials and preparation:**

The material must be able to be reshaped when it is cold. The start diameter for thread rolling corresponds to approximately the middle pitch diameter of the thread that has to be rolled and must be prepared using the necessary accuracy.

Type	Metric regular-pitch threads Ø	Metric fine-pitch threads Ø	Maximum thread length (minus 2 x thread pitch)	Minimum gap between the collet chuck and the thread	Maximum advance force [N]	Weight [kg]	
						Tool with thread rolls	Adapter
B 8-W	1.6 - 12	2 - 13	14	8	1,600	1.0	approx. 1.5
B 10-W	2 - 16	2 - 16	19	11	2,500	2.1	approx. 1.7
B 14 <sup>▪</sup>	4 - 22	4 - 35	25.5	14	5,000	4.0	approx. 2.0
B 16 <sup>▪</sup>	6 - 22	6 - 45	25.5	14	5,700	4.3	approx. 2.0
B19 <sup>▪</sup>	8 - 27	8 - 52	31	17	9,800	7.5	approx. 3.0

B13-VB	3 - 10	3 - 24	15	0.5	4,000	4.5	approx. 2.0
B16-VB	12 - 16	12 - 42	18	0.5	4,000	5.4	approx. 2.0

<sup>▪</sup> These types are also available with fine adjustment (F) of the roll play. The specific tool models differ in size. All sizes are given in mm unless otherwise noted.

# Axial Rolling Heads

Auto-opening, axially working, chip-free shaping technology

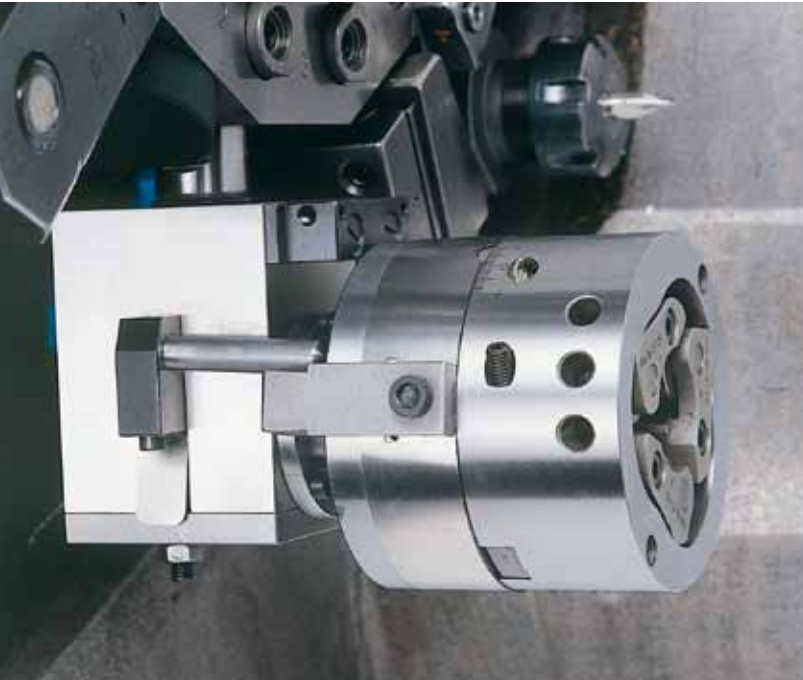

Stationary RS 16 rolling head with locking device fitted on the turret of a CNC lathe

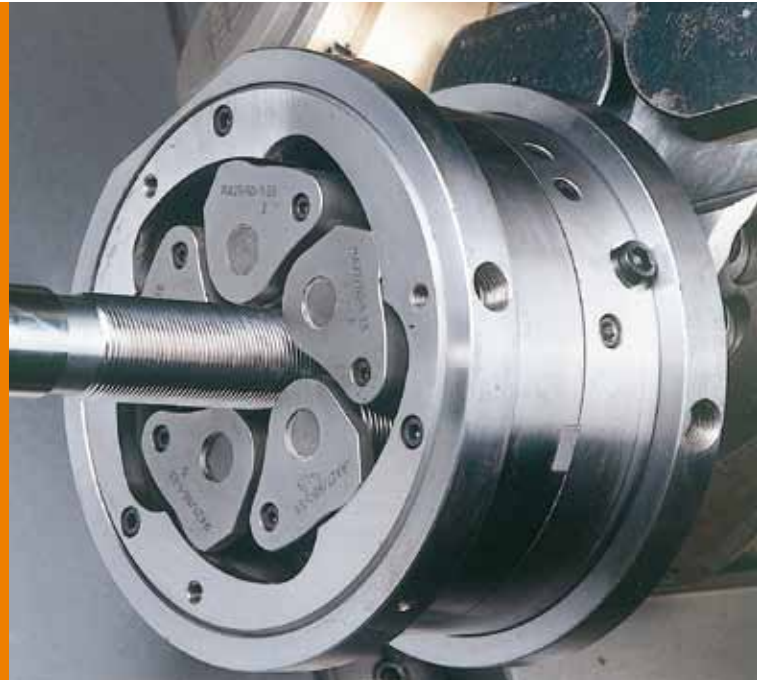

RS 60-5 thread rolling head with 5 rolls

The axially working **WAGNER® thread rolling head** rolls the superior finish threads in an unrivalled large working area.

**The large working area** of the various rolling head models is made possible by the fast and easy exchange capabilities of the roll holders. They differ in the size of the working areas and the holder angles. This ensures that the threads with different profile shapes can be machined with left-hand or right-hand threads using the same head. Other shaping work such as beading, knurling, rolling-in and smoothing can also be carried out. The heads are suitable for rotating or stationary use.

The axial head is closed by radially turning the locking lever or locking roll or by an automatic locking device. The head's opening mechanism will be activated when the feeding stops and the rolls will release the workpiece.

**Maximum productivity** can be realised by the use of high precision thread rolls, which are held in place by the roll holders. These can be optimised to match the required pitch, diameter and shape of the rolling thread. The thread roll is the ultimate shaping tool in which the profile that has to be rolled is machined as a parallel circumferential groove.

**The high flexibility** that ensures that the head can be fitted in different machines is realised by the numerous shaft versions available to you. The shaft does not include any rolling head mechanical controls and it can easily be exchanged using the screw connections.

#### Application areas:

WAGNER®-Werkzeugsysteme offers a great number of thread rolls for cylindrical and conical threads. The production of left-hand and right-hand threads is also possible as well as regular-pitch and fine-pitch threads, tube, trapeze and special threads.

Profile thread rolls are also available for special applications such as the rolling of lubricating, knurled or smooth grooves.

#### Your benefits:

- Large working areas realised through modular design
- Rotating and stationary models for use on lathes, machining centres, rotary indexing machines and special machines
- Machining of long threads
- Auto-opening for touch-free retraction

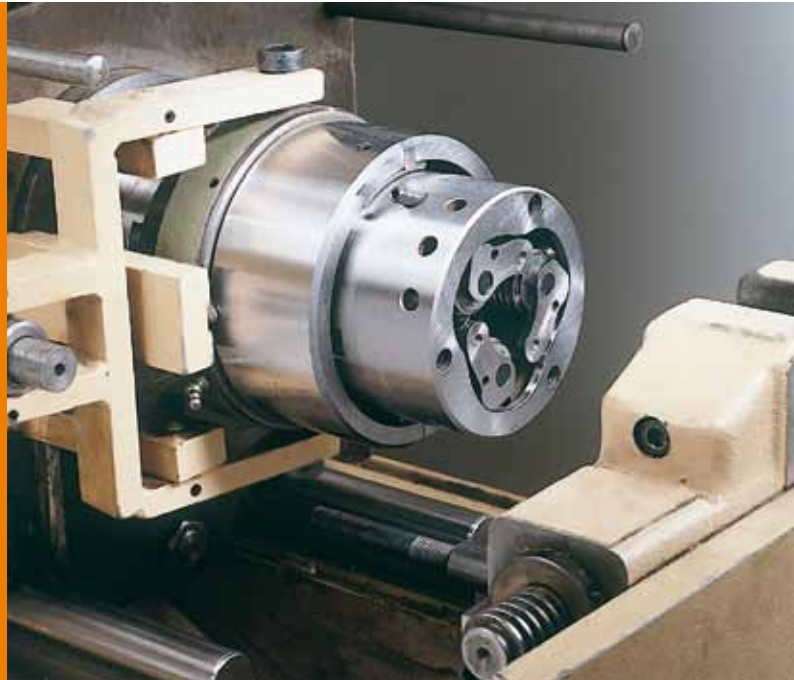

WAGNER<sup>®</sup> thread and profile rolls

Rotary RR 22-2 rolling head mounted on a slide unit spindle

### Stationary model

Type	Fine-pitch thread Nominal Ø	Regular-pitch thread Nominal Ø	Main size		Weight [kg]	Thread length	
			Head Ø	Head length		Ø up to	max. length
RS 10	2.5 - 10	2.5 - 10	66	55	1.2	10	unlimited ■
RS 16	3 - 24	3 - 16	88	72	2.7	16	unlimited
						22	27
						27	19
RS 16-VB	6 - 23	6 - 12	88	73	3.0	16	unlimited
						22	33
						23	26
RS 22-2	5 - 36	5 - 24	125	120	10.5	27	unlimited
						32	50
						36	26
RS 27/56	8 - 56	5 - 27	150	109	11.0	52	unlimited
						56	31
RS 42	8 - 45	8 - 42	190 - 200	154.5 - 162.5	28.0	42	unlimited
RS 42/75	45 - 75	-	190 - 200	154.5 - 162.5	29.5	45	unlimited
						62	86
						75	49
RS 45	12 - 54	12 - 45				48	unlimited
						54	119
RS 60-5	32 - 60	-	192	131	28.0	60	unlimited

### Rotary model

Type	Fine-pitch thread Nominal Ø	Regular-pitch thread Nominal Ø	Main size		Weight [kg]	Thread length	
			Head Ø	Head length		Ø up to	max. length
RAR 10-2	2.5 - 10	2.5 - 10	66 - 108	109.5	3.4	10	unlimited
RAR 16-2	3 - 24	3 - 16	88 - 130	126.3	5.7	16	unlimited
						22	27
						27	19
RAR 16-VB	6 - 23	6 - 12	88 - 130	127	6.0	16	unlimited
						22	33
						23	26
RR 22-2	5 - 36	5 - 24	125 - 180	180	18.9	27	unlimited
						32	50
						36	26
RR 27/56	8 - 56	5 - 27	150 - 162	175	14.5	52	unlimited
						56	31
RR 42	8 - 45	8 - 42	190 - 238	217.5	45.0	42	unlimited
RR 42/75	45 - 75	-	190 - 238	217.5	46.5	50	unlimited
						62	86
						75	49
RR 45	12 - 54	12 - 45				48	unlimited

■ The maximum thread length can be limited by the shank.

Axial rolling heads with pre-fitted rolls are available on request.  
All sizes are given in mm unless otherwise stated.

# Thread Cutting Heads

Auto-opening, axially working, chip-removing technology



ZA 22 thread cutting head with locking device



Stationary thread cutting head for the use on turning machines



Internally controlled thread cutting head

The **WAGNER® thread cutting head** is an axially working precision tool that produces top quality threads in a very short time.

The **stationary thread cutting head** is connected to the tool holder (e.g. turret) by a shaft. The precision pitch feeding moves the tool axially onto the workpiece, where the thread is cut in a single working step.

The head's opening mechanism will be activated when the feeding stops and the chasers will then release the workpiece. The retraction can now be made at a rapid traversing speed. The head is closed by axially moving the locking lever.

The **rotating thread cutting head** is flange-mounted on the machine spindles or held in chucks. The head is normally opened and closed using an external control lever.

The **large working area** of the specific cutting head models is made possible by the fast and easy exchange capabilities of the chaser holders. This makes it possible to machine different types of threads using a single head. This will also help to keep your machine's downtimes to a minimum.

**Maximum productivity** can be realised by using precision thread chasers. These can be optimised to match the required pitch and shape of the thread that has to be cut.

The **high flexibility** that ensures that the head can be fitted in different machines is realised by the numerous shaft versions available to you.

**Internally controlled** thread cutting heads have been designed for use in tool machines with controlled drawbars. These control all of the required mechanical movement processes.

#### Application areas:

The thread cutting head's capabilities include the cutting of fine-pitch or regular-pitch threads, cylindrical or conical and left-hand or right-hand threads.

The cutting head is also capable of cutting tube, trapeze or round threads as well as other special shapes in addition to sharp threads, including cutting to American or British standards.

The cutting head can also cut parallel profiles if a plunge process is used. Difficult cutting jobs and large diameter areas can be machined without any difficulties if you use our **head models WDK - WKK**.

#### Your benefits:

- Economical machining thanks to chasers that can be re-ground
- Time-saving operation thanks to single cuts
- Short downtimes thanks to exchangeable chaser holders
- Rotating and stationary use





**Stationary heads ZA 12 - 27**

Type	Regular Threads Nominal-Ø	Fine Threads Nominal Ø	Pipe Threads Nominal Ø	Head Ø	Length	Weight [kg]	Length of thread	
							up to Ø	max. length
ZA 12	1.6 - 12	2 - 16	1/16 - 1/4"	58	58	0.8	10	43
							12	30
							16	13
ZA 16	2.5 - 16	3 - 24	1/8 - 3/8"	72	70	1.8	11	51
							16	30
							24	15
ZA 22	4 - 22	4 - 38	1/8 - 3/4"	88	82	2.8	16	unlimited ▪
							22	40
							28	18
ZA 27	5 - 24	5 - 60	1/8 - 1"	110	109	6.8	18	unlimited ▪
							27	65
							50	28
ZE 39	8 - 39	10 - 80	1/8 - 2"	180	210		45	unlimited ▪
							80	30



**Rotary heads ZR 12 - 27**

Type	Regular Threads Nominal-Ø	Fine Threads Nominal Ø	Pipe Threads Nominal Ø	Head Ø	Length	Weight [kg]	Length of thread	
							up to Ø	max. length
ZR 12	1.6 - 12	2 - 16	1/16 - 1/4"	58	51	0,6	12	unlimited ▪
							16	13
ZR 16	2.5 - 16	3 - 24	1/8 - 3/8"	72	62	1.7	16	unlimited ▪
							24	15
ZR 22	4 - 22	4 - 38	1/8 - 3/4"	88	70	2.8	22	unlimited ▪
							38	18
ZR 27	5 - 24	5 - 60	1/8 - 1"	110	99	6.2	27	unlimited ▪
							50	28



**Rotary heads Z 16 - 76**

Type	Regular Threads Nominal-Ø	Fine Threads Nominal Ø	Pipe Threads Nominal Ø	Head Ø	Length	Weight [kg]	Length of thread	
							up to Ø	max. length
Z 16	4 - 16	6 - 45	1/8 - 3/8"	123	134	10	16	unlimited ▪
							45	30
Z 27	6 - 27	6 - 60	1/8 - 1"	160	145	15	30	unlimited ▪
							60	30
Z 39	8 - 39	10 - 80	1/8 - 2"	180	157	23	45	unlimited ▪
							80	30
Z 52	8 - 52	10 - 100	1/8 - 2 3/4"	200	181	31	55	unlimited ▪
							100	34
Z 64	8 - 64	10 - 100	1/8 - 2 3/4"	200	166	27	70	unlimited ▪
							100	48
Z 76	-	30 - 120	1 - 4"	250	216	50	95	unlimited ▪
							120	48



**Rotary heads WDK - WKK**

Type	Regular Threads Nominal-Ø	Fine Threads Nominal Ø	Pipe Threads Nominal Ø	Head Ø	Length	Weight [kg]	Length of thread	
							up to Ø	max. length
WDK	8 - 52	- 65	R1/4 - 2"	310	252	54	65	unlimited
							> 65	77
WEK	8 - 52	- 95	R1/4 - 3"	310	252	54	95	unlimited
							> 95	74
WGK	12 - 76	- 95	R1/2 - 3"	370	290	94	95	unlimited
							> 95	90
WHK	12 - 76	- 120	R1/2 - 4"	370	282	94	120	unlimited
							> 120	74
WJK	24 - 100	- 120	R1 - 4"	410	294	145	120	unlimited
							> 120	80
WKK	24 - 100	- 175	R1 - 6"	410	300	145	175	unlimited
							> 175	77

▪ The maximum thread length can be limited by the shank.

All sizes are given in mm unless otherwise stated.

Internally controlled cutting heads and cutting heads for tapered threads are available on request.

# Multi-Cutter Turning Heads

For reducing diameters quickly and precisely



DSD 16 and DSD 12 Three-Cutter Turning Heads

**WAGNER® multi-cutter turning heads** enable the diameters of workpieces to be reduced by up to 6 mm in a single pass. The original material can be round, square or hexagonal and pulled or rolled. This also means that all machinable materials can be processed.

The four-cutter turning head (MSD) as well as the three-cutter turning head (DSD) models are available in a huge range of turning diameters, which cover all of our customer's requirements.

Both heads are fitted with three or four commercial **carbide cutting inserts** (either SCMT or CCMT), which can also be replaced by precision-ground WAGNER® carbide cutting inserts, depending on the workpiece surface finish requirements.

**Easy handling** is ensured by the **centralised diameter adjustment** of the three or four cutting inserts. Any corrections can be easily made in the machine. The turning diameter can also be preset by adjusting the positioning of the four cutting inserts.

**Perfect surfaces** can be realised by the MSD's cut-lifting function. When the turning length has been reached the head is opened and the four carbide inserts are lifted off of the workpiece. The non-touch retraction process ensures that no grooves are cut into the workpiece.

The carbide inserts guarantee **speed**. They divide the chips into three or four equal parts, which results in the multi-cutter turning head advancing 3 to 4 times faster than normal.

The radial force that the workpiece is subjected to is nullified by the cutters, which means that a **turning accuracy** of 0.01 to 0.02 mm can be realised over the diameter. Large and labile tool lengths can be turned with excellent results.



MSD 20-R four-cutter rotary turning head ▲  
MSD 20 with external activation on tool turrets ►

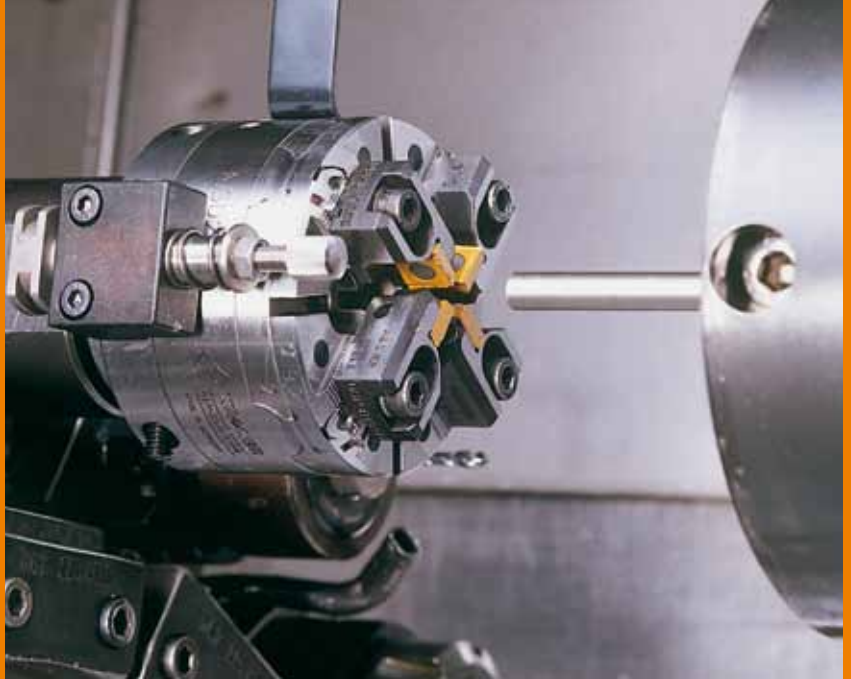

**Your benefits:**

- Tremendous cutting performance is realised thanks to the 3 to 4 times faster advance rate
- Centralised diameter adjusting
- Very high turning accuracies can be realised (0.01 to 0.02 over the diameter)
- Perfect surfaces thanks to the cut-lifting function that is activated by the opening process (MSD)
- DIN-ISO carbide inserts or WAGNER<sup>®</sup> precision carbide inserts can be used



Type	Number of cutting inserts	Opening function	Turning Ø	Head Ø	Head length approx.	Weight [kg]
MSD 20	4	yes	2 - 16 (20)	70	75	1.7
MSD 20R	4	yes	2 - 16 (20)	70	82	2.0
MSD 30	4	yes	16 - 30	84	75	2.1
MSD 30R	4	yes	16 - 30	84	82	2.8
DSD 12	3	no	1 - 12	55	40	0.9
DSD 16	3	no	2 - 16	70	48	1.4

All sizes are given in mm unless otherwise stated.

# Driven Tools

Axial or radial, axial offset, shortened or relocated



Axially driven tools



Radially driven tools



Axially offset driven tools

**Driven tools** supplied by WAGNER® have been in use throughout the world for many years now. They will expand your lathe and machining centre options by the addition of axial and radial working and this gives the user new ways with regard to the production of rotation symmetric parts.

WAGNER® tool heads enable full machining to be carried out on a single machine and in practice this will transpose the performance of all standard machines and cutting tools.

The demand orientated versions included in our range of products will enable your machine to be fitted with:

- Axially driven tools
- Radially driven tools
- With internal coolant supply
- Without an internal coolant supply
- Angle-adjustable tool heads
- Special tool heads

Our extensive expertise is available to you from planning the machining job up to the service.

**For use with turrets made by:**

- SAUTER
- DUPLOMATIC
- INDEX
- CITIZEN-BOLEY
- EMCO
- BARUFFALDI
- OKUMA
- NAKAMURA
- MORI-SEIKI
- Others upon request

**Tool holders:**

- ER DIN 6499 collet chuck
- DIN 6358 milling spindle
- DIN 1835 Weldon
- Thread-cutting tap
- Others

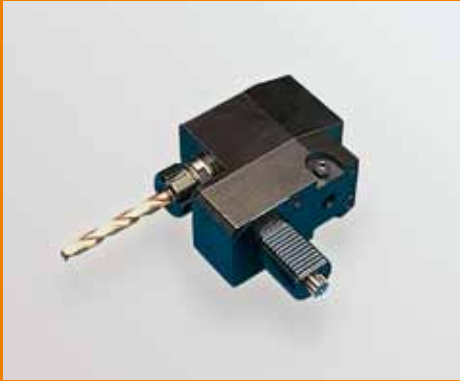

Radially relocated driven tools





#### Your benefits:

- The **spindle's concentricity** with a value of  $\leq 0.005$  mm enables high-precision tools to be used with cutters made from carbide or cutting ceramics.
- The very **high basic accuracy** enables defined precision declarations to be made and it also simplifies the alignment and setting up processes.
- The **spindle bearing** in precision roller bearings increases the spindle's rigidity and this improves the load-bearing capacity in both the axial and radial directions.
- A **labyrinth ring-seal** is used to protect them from being penetrated by the cooling water. The seal's frictional heat is extremely low, even at circumferential speeds of up to 30 m/s.
- Our tools only use **high-accuracy gears**. All of the gear parts are lapped or ground.

# Production Example

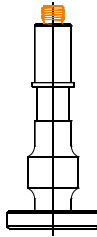
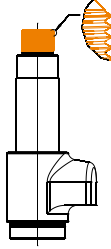
This shows you what our tools can do.

Workpiece				
Thread	3/8"-24 UNF	M15 x 0,5	Tr 16x4	
Start Ø				8 mm
Thread length	8 mm	10 mm	70 mm	
Turning Ø/ Turning length				4.8 mm/ 30 mm
Material	MS 58	C 45	X20 Cr13	St 37, galvanised
Tool	ZA 16 cutting head	B15-W thread rolling attachment	RS 27/56 thread rolling head	MSD 20 multi-cutter turning head
Machining speed	25 m/min	78 m/min	45 m/min	100 m/min
Feed rate	1.05 mm/rev.	0.12 mm/rev.	3.90 mm/rev.	0.30 mm
Cutting life	60,000 pieces per regrinding	80,000 pieces	8,000 pieces	
Machine	Automatic turret lathe	Multi-spindle automatic lathe	CNC machine	CNC lathe
Machining time	0.6 seconds	0.9 seconds	1.16 seconds	1.5 seconds

# Global Partners

Our trading partners at a glance

## Austria

ALPHATOOL Werkzeugsysteme  
Postfach  
Müllerenstrasse 3  
CH-8604 Volketswil  
☎ +41 44 908 30 50  
☎ +41 44 908 30 59  
info@alphatool.ch  
www.alphatool.ch

## China

Wagner Werkzeugsysteme Müller GmbH  
Büro China  
Meiyuan Xincun, Dabei Xiang 7-3  
CN - 210018 Nanjing  
☎ +86 25 84729068  
☎ +86 25 84725149  
a.ma@bw-i.cn  
www.wagner-werkzeug.de

## Czech Republic

ALBA Precision, spol. S r.o.  
Sipková 18  
CZ-620 00 Brno  
☎ +420 548 22 64 00  
☎ +420 548 53 26 89  
rs@albaprecision.cz  
www.albaprecision.cz

## France

Filetages WAGNER  
16, rue Owen Chamberlain  
B.P. 314  
FR-85303 Challans Cedex  
☎ 02 51 93 00 83  
☎ 02 51 93 00 47  
From abroad:  
☎ +41 44 908 30 54  
☎ +41 44 908 30 59  
info@alphatool.ch  
www.filetages-wagner.com

## Great Britain

Floyd Automatic Tooling Ltd.  
17 Bondor Business Centre  
Baldock, Herts, SG7 6HP  
☎ +44 14 62 49 19 19  
☎ +44 14 62 49 08 35  
web.sales@floydautomatic.co.uk  
www.floydautomatic.co.uk

## Italy

ALPHATOOL Werkzeugsysteme  
Müllerenstrasse 3/ Postfach  
CH-8604 Volketswil  
☎ +41 44 908 30 54  
☎ +41 44 908 30 59  
info@alphatool.ch  
www.alphatool.ch  
PIVA. DE 218861594

## Japan

GOSHO Co. Ltd.  
Tokyo Main Office  
33-3-4 Chome  
Ikebukuro  
Toshima-Ku  
Tokyo 171-0014  
☎ +81 3 5911 6333  
☎ +81 3 5911 8107

## Poland

ITT Technika  
ul. Nowowiejska 29  
PL-63-233 Góra / k. Jarocina  
☎ +48 62 740 9042  
☎ +48 62 720 9030  
itt@itt-technika.pl  
www.itt-technika.pl

## TML Technologie

ul. Mala Dworcowa 8A  
83-400 Koscierzyna  
☎ +48 58 686 67 77  
☎ +48 58 686 67 77  
office@tml-technologie.pl  
www.tml-technologie.pl

## Slovakia

ALBA Precision, s.r.o.  
Robotnicka 6  
974 01 Banská Bystrica  
☎ +421 48 414 86 27  
☎ +421 48 414 86 27  
albaprecision@albaprecision.sk  
www.albaprecision.sk

## Spain

MTC S.L.  
Maquinaria Tecnologia Calidad, S.L.  
C/. Gran Bretanya, 16  
Pol. Ind. Pla de Llerona  
E-08520 Les Franqueses del Vallès  
☎ +34 93 870 08 85  
☎ +34 93 879 16 89  
mtc.sl@mtcbarcelona.com

## Sweden

Duroc Machine Tool AB  
Box 340  
SE-183 13 TÄBY  
☎ +46 8 630 23 00  
☎ +46 8 630 23 01  
info.machinetool.se@duroc.com  
www.duroc.com

## Switzerland

ALPHATOOL Werkzeugsysteme  
Postfach  
Müllerenstrasse 3  
CH-8604 Volketswil  
☎ +41 44 908 30 50  
☎ +41 44 908 30 59  
info@alphatool.ch  
www.alphatool.ch

## Turkey

Hidkom Mühendislik - Mümessillik Ltd.  
O.S.B. 75.Yıl Cd. Demirciler Sit. B Blok  
No:2 P.K.  
TR-16159 Nilüfer - Bursa  
☎ +90 (224) 243 82 92  
☎ +90 (224) 243 63 65  
hidkom@hidkom.com  
www.hidkom.com

## United States

Wagner Carbide Saw. Div.  
TOOLING ETC., L.L.C.  
250 Hallock Avenue  
Middlesex, NJ 08846  
☎ +1 732 752 80 80  
☎ +1 732 752 82 09  
info@wagnercarbidesaw.com  
www.wagnercarbidesaw.com



Gutenbergstraße 4/1  
D - 72124 Pliezhausen  
Phone +49 71 27 97 33 00  
Fax +49 71 27 97 33 90  
Email [info@wagner-werkzeug.de](mailto:info@wagner-werkzeug.de)  
Web [www.wagner-werkzeug.de](http://www.wagner-werkzeug.de)