

## Wobble Broaching Instructions

Broaching a profile in a turned part can often be completed in the original setup on a lathe or CNC turning machine. This eliminates the need for secondary operations. The 'wobble broaching' method can also be applied to broaching on a CNC machining centre or vertical mill. The difference being that the broach holder is rotating in the machine spindle and the part is stationary instead of the reverse, as on a turning machine. Below are some details to help understand how and why wobble broaching works.

### Wobble Broaching Explained

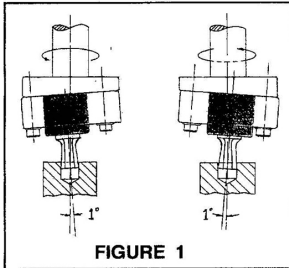

FIGURE 1

#### 1. Cutting Principle

The basic principle that makes this tool work is the same for all tools regardless of the manufacturer. The centreline of the cutting tool is inclined at 1° from the centreline of the work piece. This causes the broach to shear its way into the part with a scalloping effect as it is fed into the work piece. The easiest way to visualize this cutting action is to picture it as if the work piece were stationary and the broach holder were rotating, instead of having the work piece rotating and the holder stationary as is normally the case on a lathe. As can be seen in Figure 1, the broaching cutter spindle is driven into the part at a 2° included angle of its cone of rotation. This causes the broach to cut only on its leading edge, i.e. one flat at a time. This eases the load of the cut and creates a shearing, rotational cutting action so that the cutting tool is actually spiralling its way into the part.

#### 2. Construction

Since all holders operate on the same principle, the only real difference between broaching tools is holder and cutting tool life. The usual cause of holder breakdown is bearing failure. On FLO-Tool broach holders high quality bearings are used making the tool more rigid, which gives longer cutting tool life and more accurate and uniform parts. Spare bearing sets are available and are easily fitted.

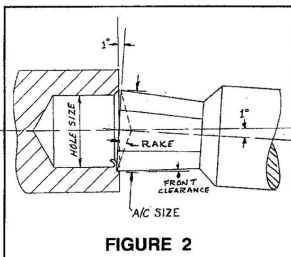

FIGURE 2

#### 3. Feed Rate

As the broach tool is offset 1°, it is necessary that the helix angle of the feed rate does not exceed 1°. If it does, the broach will bottom out, crowding the metal instead of cutting, causing tool wear or breakage. (See Figure 2.) Therefore, the best feed rate should be the equivalent of 1 helical maximum. To maintain this 1 degree helical feed rate, the feed rate per revolution can be calculated by multiplying the diameter that is to be broached by .016. (e.g. 6.35mm part diameter x .016 = 0.10mm maximum feed rate per revolution.) Rotational speed (RPM) has very little effect on cutter life, since the cutter rotates with the work piece. However, life of the spindle bearings is affected by the speed of rotation.

#### 4. Hole Preparation

For internal broaching, the hole should be drilled 0.13mm-0.4mm larger than across flats dimension of the broach, and countersunk at 90 degrees to slightly larger than the across points dimension of broach. Drill the hole as deep as possible to leave room for chip accumulation.

#### 5. Broach Geometry

Internal broaches are ground with a 1-1/2° maximum back clearance on all surfaces. The face is dished at a 4-8 degree clearance. The larger end of the broach is made to the high side of the part tolerance since the broach gets smaller as it is sharpened.

#### 6. Part Configuration

Hexagon and Square shapes can usually be broached without much difficulty. Problems may be encountered when broaching other shapes, such as splines or keyways, especially when the depth of the cut is greater than half its width. If the chip being cut is too thick and does not curl away from the cutting edge of the broach, the broach can jam up.

Continued..

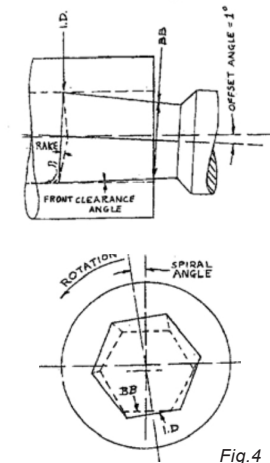
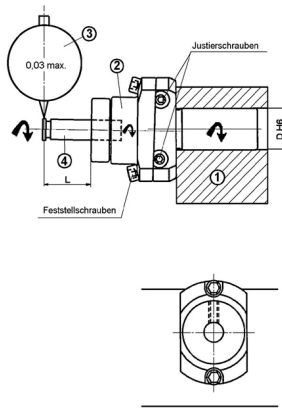

Fig.4

### 7. Spiralling

When broaching deep profiles spiralling of the broached form can occur. This is caused by the back taper on the broach. Since the broach is driven by the leading edge of the hole (ID) against the nearest surface of the broach (BB), the space between the broach and the hole caused by the back clearance allows the broach to rotate slightly and cut a spiral as shown in Figure 4. The greater the back clearance on the broach, the greater the spiralling action. For this reason, a maximum 1-1/4° back clearance is recommended instead of 1-1/2 degree more commonly used. Ideally a 1-degree back clearance would eliminate all spiralling, but, due to machine or holder inaccuracies, dragging action might cause other problems. Spiralling will also occur if the broach is not properly centred. The more the form is shifted off to one side, the greater the amount of spiralling. The cure for this effect is reversing the spindle rotation half way into the part. This causes the broach to be driven by the opposite wall of the hole thereby reversing the direction of the spiralling and making the hole straighter.



### 8. Setting the Holder on Centre

It is important that the broach is centred as close as possible to the centre of the work piece. Improper centre setting will cause uneven hole profiles, oversize holes, spiralling, excessive cutter wear and holder wear. Therefore, it is essential that the following instructions are observed when setting up internal broach cutters.

### To Centre Cutter:

Clamp shank of broach holder in a "V" block (1). Install the broach cutter or setting piece (4) in the offset spindle hole. While rotating the offset spindle with the broach secured in it, check that the extreme end of the broach indicates to within 0.03mm concentricity. Lock broach securely in place.



This step is essential since it is necessary to correct for the inherent run out caused by the clearances between the mounting hole diameter and the broach shank diameter and any eccentricities built into the holder spindle and the broach itself.

### To Centre The Tool Holder:

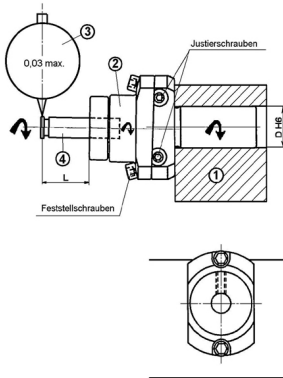

To ensure the broach to holder alignment is correct, with the holder mounted in the machine, or in a vee block, loosen the angled clamp screws slightly. Don't over loosen them, as a small movement of these screws can move the head a large amount, as they are angled they work against each other to give height adjustment. Next loosen the shank of the holder to allow the shank to rotate in the vee block or machine tool holder (1). With the rotating spindle, i.e. the broach (4), held stationary, rotate the complete holder (2) and indicate the extreme end of the broach as shown above to within .03mm TIR. The head is adjusted by tightening or loosening the angled body adjusting screws or side flanged head screws. When .03mm TIR maximum is attained, lock head in place by tightening the angled clamp screws.



This step is also essential to being certain that the extreme end face of the broach is concentric with the shank of the broach holder itself. If the machine condition is such that the turret hole is not in line with the spindle, the broach can be centred as follows: Countersink the hole at 45° to a diameter larger than the across corners of the broach. Loosen the clamp screws so that the body of tool is free to move. Advance the tool holder into the work piece, allowing the broaching tool to centre itself in the countersink of the work piece. While it is in this position, lock the body in place by tightening the clamp screws, being careful not to disturb the tool alignment. If the tool does not cut the proper hole size, corrections can be made by adjusting the screws.

### Pre-Drilling / Boring Before Broaching

Normally holes must be a little bigger than the effective dimension across flats of the broach to reduce the pressure on the broach. In mid-steel (~60 - 80 dN/mn<sup>2</sup>). The following tolerances are a good starting point:

**1.5-3mm = +0.03/+0.06 3-6mm = +0.04/+0.08 6-10mm = +0.06/ +0.12**  
**10-16mm = +0.10/+0.20 >16mm = +0.15/+0.30**

These are indications and can be decreased for softer materials and increased for tougher materials. In tougher materials it is better to pre-drill as large as possible to relieve the pressure on the broach.

### Depth Of Holes

Usually, 1,3 / 1,5 x depth of profile is recommended. The clearance must be sufficient for chips pushed by the broach. If the component is to be treated, (i.e. case hardened) it may be necessary to drill out the chips with a drill 0.1/0.2 smaller than the initial drill. This operation eliminates the risk of salt being trapped behind chips causing corrosion later. The maximum eccentricity of bore before broaching must not exceed 0.02 / 0.04 according to the broach size.

### Broach Pre-Guidance

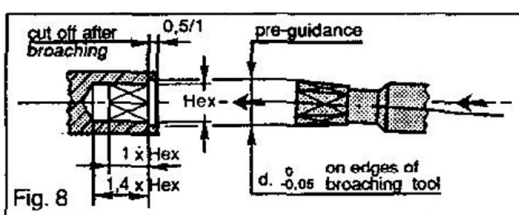

A 60° or 90° chamfer, a little bigger than broaching counterbore tool dimension across corners, is usually suitable. If rotation speed is relatively high, it can be necessary to retouch the chamfer after broaching. When exact concentricity is required, counterbore of 0.5mm depth, the same or just smaller in diameter to the broach across corners, gives the best solution; this pre-bore holds the broach concentrically when broaching is starting. After, the material can be cut off and an adequate chamfer can be made.

## Broach Rotating Speed

The principle of the 1° inclined rotating broach permits high-speed application; 1500 to 3000 RPM is possible, because rotating speed has no influence on cutting speed. However, at a very high speed, the cutting edges of the broach tend to mill the material when starting, until speed is synchronized. With very small broaches, this can cause the broach to wear prematurely because of the relation between the diameter of the cutter and spindle inertia is unfavourable. To avoid this, start broaching with a slow rotation or even stationary, and then increase the speed when the broach is engaged enough.

## Feed

The choice of feed is mainly dependant on the material characteristics. In a mild-steel, we recommend 0.03 to 0.06 mm per revolution. If the machine thrust force is sufficient, the feed can be doubled even trebled in brass or aluminium. It is better to start the batch machining with a reasonable feed, then increase it progressively. In case of large profile sizes in heavy material, it is necessary to reduce the feed up to 0.01 mm per revolution.

## Coolant

Usual coolant or cutting oil. However oils with EP additives are recommended.

## Re-Sharpening Of Broaches

Usually, only one re-sharpening on the front face is possible (cutting angle 4 to 8°), if the tool is in reasonable condition, otherwise it may be impossible to regrind within tolerance. For high strength materials face can be ground flat or spherically (approx 1° negative).

## Comments

It is possible to observe the profile concentricity with regular trace of bore in the middle of each flat, when drilling slightly oversize as recommended.

## Square and Spline Profiles:

The broaching of square or spline profiles is possible. However, compared with the broaching of hexagon profiles, there are limits. A much larger material cross section (thickness of chip) is produced, which increases the cutting pressure substantially. For hexagon profiles, experience shows that, on mild steel, the thickness of chip between 1 and 1.5 mm is produced. With square profiles within the range of 10 to 16 mm, even up to 20 mm, a thickness of chip from 1.5 to 2mm, is produced. These are approximate values, which can be exceeded with soft materials and reduced with tougher materials. During a square broaching procedure the pre-drilling must be considerably larger than the finished size, thus the cutting force and the cutting pressure is reduced accordingly. In order to avoid chipping of the cutting edges, in most cases, a radius on each of the 4 corners is necessary. The larger the edge break, the smaller the thickness of chip. We supply square and spline broaches on request in most sizes and for various materials.



When ordering, please indicate the "preferred" across points diameter (or edge diameter). If not known, the broach will be made to the theoretical diameter less 0.40mm.

Example:  $\varnothing = (A/F \times 1.414) - 0.40\text{mm}$

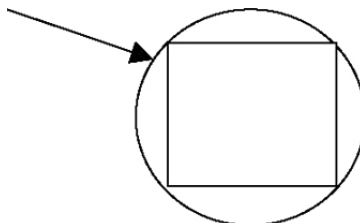

## Broaches

### Torx Broaches

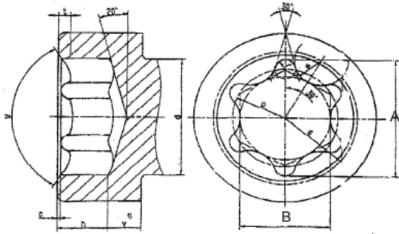

Torx 'T'	A (Min)	A (Max)	B (Min)	B (Max)
T6	1.72	1.78	1.25	1.30
T8	2.39	2.44	1.72	1.77
T10	2.79	2.844	2.01	2.07
T15	3.32	3.376	2.37	2.44
T20	3.88	3.962	2.78	2.86
T25	4.48	4.559	3.20	3.28
T30	5.55	5.651	3.99	4.07
T40	6.70	6.78	4.79	4.86
T45	7.87	7.97	5.58	5.68
T50	8.89	8.99	6.40	6.50
T55	11.26	11.404	7.95	8.10

### Broaching Heads - Adjustable

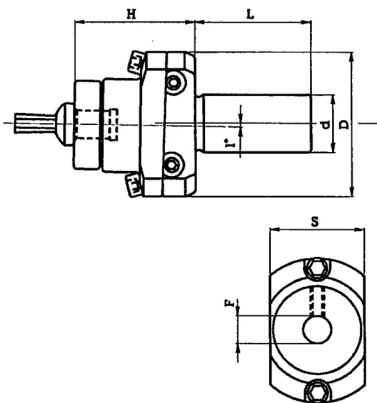

Cat No.	d	D	H	L	S	F
U175.112	12	50	34	35	30	8
U175.114	14	50	34	35	30	8
U175.115	5/8"	50	34	35	30	8
U175.116	16	50	34	35	30	8
U175.119	3/4"	50	34	46	30	8
U175.120	20	50	34	46	30	8
U175.125	25	50	34	46	30	8
U175.125a	25	50	34	80	30	8
U175.125b	25	50	34	150	30	8
U175.126	1"	50	34	46	30	8
U175.122c	22	50	34	30	30	8
U175.122	22	50	34	80	30	8
U175.219	3/4"	62	52	50	40,5	12
U175.220	20	62	52	50	40,5	12
U175.222	22	62	52	50	40,5	12
U175.225	25	62	52	50	40,5	12
U175.226	1"	62	52	50	40,5	12
U175.230	30	62	52	50	40,5	12
U175.231	31,75	62	52	50	40,5	12
U175.232	32	62	52	50	40,5	12

1-6mm (1/4") hexagon with d = Ø8mm shank

2-32mm hexagon with d = Ø12mm shank

Torx from T6-T15 with 8mm shank. Torx from T6-T55 with 12mm shank.

Other profiles & sizes on request

## Broaches

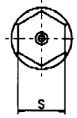
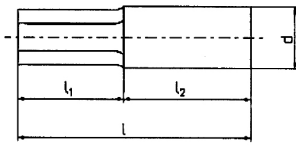

Cat No.	D	L	L1	L2	S
V808.010S	8	30	12	18	1
V808.013S	8	30	12	18	1,3
V808.015S	8	30	12	18	1,5
V808.020S	8	30	12	18	2
V808.025S	8	30	12	18	2,5
V808.030S	8	30	12	18	3
V808.032S	8	30	12	18	3,175
V808.040S	8	30	15	15	4
V808.050S	8	30	15	15	5
V808.060S	8	30	15	15	6
V808.635S	8	30	15	15	6,35
V812.06T	12	40	12	22	T6
V812.07T	12	40	12	22	T7
V812.08T	12	40	12	22	T8
V812.10T	12	40	12	22	T10
V812.15T	12	40	12	22	T15
V812.20T	12	40	12	22	T20
V812.25T	12	40	12	22	T25
V812.30T	12	40	12	22	T30
V812.40T	12	40	12	22	T40
V812.45T	12	40	12	22	T45
V812.50T	12	40	12	22	T50
V812.55T	12	40	12	22	T55

Cat No.	D	L	L1	L2	S
V812.020S	12	40	15	25	2
V812.025S	12	40	15	25	2,5
V812.030S	12	40	15	25	3
V812.040S	12	40	15	25	4
V812.050S	12	40	18	22	5
V812.060S	12	40	18	22	6
V812.070S	12	40	18	22	7
V812.080S	12	40	18	22	8
V812.095S	12	40	18	22	9,5
V812.100S	12	40	18	22	10
V812.110S	12	40	18	22	11
V812.120S	12	40	18	22	12
V812.130S	12	40	18	22	13
V812.140S	12	40	18	22	14
V812.150S	12	40	18	22	15
V812.170S	12	40	18	22	17
V812.190S	12	40	18	22	19
V812.200S	12	40	18	22	20
V812.220S	12	40	18	22	22
V812.270S	12	40	18	22	27
V812.320S	12	40	18	22	32

S = Hexagon T = Torx  
Other dimensions and profiles to order

**Typical Dimensional & Torque Specifications**

For TORX Tools for use with Internal Socket Head Type TORX Screws

Torx Size	Inch	Metric	Max Torque
T1	0.031"	0.81 mm	0.097 N m
T2	0.036"	0.93 mm	0.141 N m
T3	0.046"	1.10 mm	0.254 N m
T4	0.050"	1.28 mm	0.373 N m
T5	0.055"	1.42 mm	0.510 N m
T6	0.066"	1.70 mm	0.910 N m
T7	0.078"	1.99 mm	1.70 N m
T8	0.090"	2.31 mm	2.6 N m
T9	0.098"	2.50 mm	3.3 N m
T10	0.107"	2.74 mm	4.5 N m
T15	0.128"	3.27 mm	7.6 N m
T20	0.151"	3.86 mm	12.6 N m
T25	0.173"	4.43 mm	18.9 N m
T27	0.195"	4.99 mm	26.9 N m
T30	0.216"	5.52 mm	37.4 N m
T40	0.260"	6.65 mm	65.0 N m
T45	0.306"	7.82 mm	103.2 N m
T50	0.346"	8.83 mm	158 N m
T55	0.440"	11.22 mm	256 N m
T60	0.519"	13.25 mm	445 N m
T70	0.610"	15.51 mm	700 N m
T80	0.690"	17.54 mm	1048 N m
T90	0.784"	19.92 mm	1483 N m
T100	0.871"	22.13 mm	2048 N m

**Typical Dimensional Specifications of TORX Sockets or Nut drivers**

For use with External TORX Head Type Bolts.

Socket Size	Inch	Metric
E-4	0.150"	3.83 mm
E-5	0.185"	4.72 mm
E-6	0.225"	5.69 mm
E-7	0.241"	6.17 mm
E-8	0.292"	7.47 mm
E-10	0.367"	9.37 mm
E-12	0.436"	11.12 mm
E-14	0.503"	12.85 mm
E-16	0.576"	14.71 mm
E-18	0.652"	16.64 mm
E-20	0.722"	18.41 mm

## Broaching Head - Fixed - Small Diameter

For Ø8 x 30mm Broaches

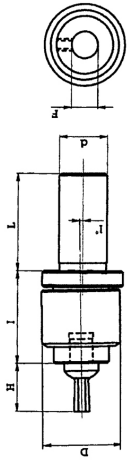

Cat No.	d	L	I	D	H	F
U175.610	10	35	38	32	18	8
U175.612	12	35	38	32	18	8
U175.614	14	35	38	32	18	8
U175.616	16	35	38	32	18	8
U175.619	3/4"	50	38	32	18	8
U175.620	20	50	38	32	18	8
U175.622	22	50	38	32	18	8
U175.625	25	50	38	32	18	8
U175.126	1"	50	38	32	18	8

S = Hexagon T = Torx  
Other dimensions and profiles to order

## Broaching Head - Fixed - Small Diameter

For Ø5 x 17mm Broaches

Cat No.	d	L	I	D	H	F
U175.508	8	35	34	22	10	5
U175.510	10	35	34	22	10	5
U175.512	12	35	34	22	10	5
U175.514	14	35	34	22	10	5
U175.515	5/8"	35	34	22	10	5
U175.516	16	35	34	22	10	5
U175.519	3/4"	50	34	22	10	5
U175.520	20	50	34	22	10	5
U175.522	22	50	34	22	10	5
U175.525	25	50	34	22	10	5
U175.526	1"	50	34	22	10	5

## Broaching Head - Fixed - Small Diameter

Standard Sizes Ø5x17 Broaches

Cat No.	d
V805.020S	2.0
V805.025S	2.5
V805.030S	3.0
V805.035S	3.5
V805.040S	4.0
V805.050S	5.0